



Part Number : [1200669655](#)

Product Description : Micro-Change (M12) Double-Ended Cordset with Knurled Hexnut, 4 Poles, Male (90°) to Female (90°), 22 AWG, Yellow TPU WSOR Cable, Yellow Overmold, 15.0m (49.21') Length

Series Number : 120066

Status : Active

Product Category : Circular Industrial Cordsets

Engineering Number : 884033B55M150Y

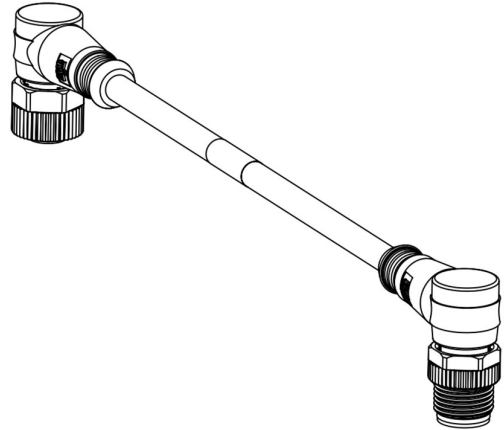

Documents & Resources

Drawings

[1200669655_sd.pdf](#)

Product Environment Compliance

Compliance

GADSL/IMDS	Not Relevant
China RoHS	Not Relevant
EU ELV	Compliant with Exemption 3 per 2000/53/EC
Low-Halogen Status	Not Relevant
REACH SVHC	Contains Lead per D(2024)6225-DC (07 Nov 2024)
EU RoHS	Compliant with Exemption 6(c) per EU 2015/863

Multiple Part Product Compliance Statements

- Eu RoHS
- REACH SVHC
- Low-Halogen

Multiple Part Industry Compliance Documents

- IPC 1752A Class C
- IPC 1752A Class D
- Molex Product Compliance Declaration

- IEC-62474

- chemSHERPA (xml)

EU RoHS Certificate of Compliance

Part Details

General

Status	Active
Category	Circular Industrial Cordsets
Series	120066
Description	Micro-Change (M12) Double-Ended Cordset with Knurled Hexnut, 4 Poles, Male (90°) to Female (90°), 22 AWG, Yellow TPU WSOR Cable, Yellow Overmold, 15.0m (49.21') Length
IP Rating	IP67
Product Name	Micro-Change (M12)
Type	Double Ended
UPC	193264202959

Agency

UL	E152210
----	---------

Electrical

Current - Maximum per Contact	4.0A
Voltage - Maximum	60V

Physical

Cable Diameter	5.10mm (.201")
Cable Length	15.0m (49.21')
Color - Cable Jacket	Yellow
Connector End A	Micro-Change (M12)
Connector End B	Micro-Change (M12)
Coupling Style	Threaded
Gender	Female-Male
Keyway	Single
LED Indicator	None

Material - Cable Jacket	TPU
Material - Connector Body	TPU
Material - Contact	Brass
Material - Coupling Nut	Nickel-plated Brass
Material - O-Ring	FPM
Material - Plating Mating	Gold
Net Weight	1336.000/g
Orientation	90° to 90°
Poles	4
Temperature Range - Operating	-25° to +80°C
Wire/Cable Type	UL 21215
Wire Size (AWG)	22

This document was generated on Mar 27, 2025