



Part Number : [1202470041](#)

Product Description : MPIS Nano-Change (M8) Passive Junction Box, Top-Mount, 6 Ports, LED for PNP Sensor, WSOR Cable, 10.0m Length

Series Number : 120247

Status : Active

Product Category : Passive Distribution Boxes

Engineering Number : BEB601P-FBW-10

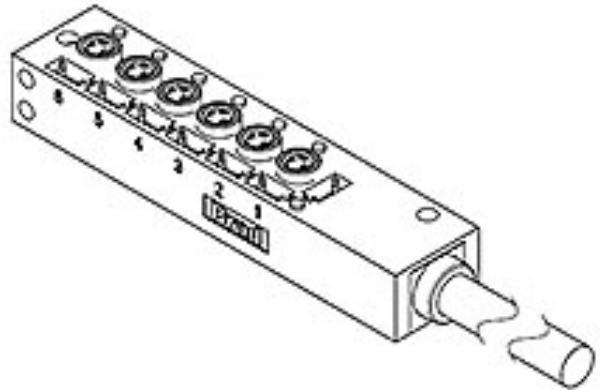

---

## Documents & Resources

### Drawings

[1202470041\\_sd.pdf](#)

---

## Product Environment Compliance

### Compliance

GADSL/IMDS	Not Relevant
China RoHS	
EU ELV	Not Relevant
Low-Halogen Status	Not Reviewed per IEC 61249-2-21
REACH SVHC	Not Contained per ED/21/2016 (20 June 2016)
EU RoHS	Compliant with Exemption 6(c) per EU 2015/863

### Multiple Part Product Compliance Statements

- Eu RoHS
- REACH SVHC
- Low-Halogen

### Multiple Part Industry Compliance Documents

- IPC 1752A Class C
- IPC 1752A Class D
- Molex Product Compliance Declaration
- IEC-62474
- chemSHERPA (xml)

## Part Details

### General

Status	Active
Category	Passive Distribution Boxes
Series	120247
Description	MPIS Nano-Change (M8) Passive Junction Box, Top-Mount, 6 Ports, LED for PNP Sensor, WSOR Cable, 10.0m Length
IP Rating	IP67, IP68
Product Name	MPIS
UPC	889056140577

### Agency

UL	E152210
----	---------

### Electrical

Current - Maximum per Contact	12.0A per module, 4.0A per port
Functional Wiring	PNP
Voltage - Maximum	10-30V DC
Wiring Configuration	Single I/O per Port

### Physical

Bus I/O	N/A
Cable Connector Orientation	Straight
Cable Length	10.0m
Home Run Cable Length	10.0m
Home Run Connector	N/A
Home Run Interface	Pigtail
Keyway	A-Coded
LED Indicator	PNP Sensors
Material - Cable Jacket	TPU
Material - Housing	PBT
Material - Metal	Copper Alloy

Material - Plating Mating	Gold
Net Weight	987.600/g
Orientation	Top-Mount
Poles	3
Poles (wired)	3
Ports	6
Temperature Range - Operating	-25°C to +85°C
Wire/Cable Type	WSOR

---

This document was generated on Mar 27, 2025