



Part Number : [1202510004](#)

Product Description : MPIS Ultra-Lock (M12) Passive Junction Box, Top-Mount, 8 Ports / 4 Poles, PNP Sensor LED Indicators, 5.0m Length, Single IO Per Port

Series Number : 120119

Status : Active

Product Category : Passive Distribution Boxes

Engineering Number : BKB800P-FBW-05

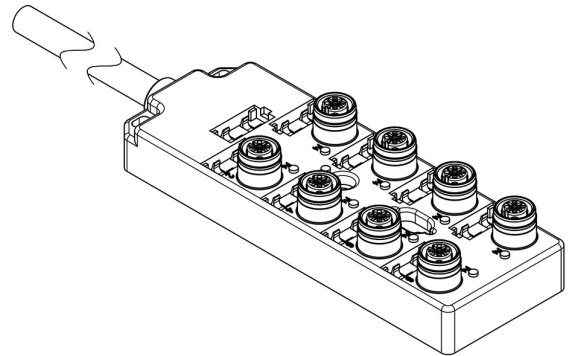

Documents & Resources

Drawings

[1202510004_sd.pdf](#)

Product Environment Compliance

Compliance

GADSL/IMDS	Not Relevant
China RoHS	Not Relevant
EU ELV	Compliant with Exemption 3 per 2000/53/EC
Low-Halogen Status	Not Relevant
REACH SVHC	Contains Lead; Triphenyl-phosphate per D(2024)7663-DC (21 Jan 2025)
EU RoHS	Compliant with Exemption 6(c) per EU 2015/863

Multiple Part Product Compliance Statements

- Eu RoHS
- REACH SVHC
- Low-Halogen

Multiple Part Industry Compliance Documents

- IPC 1752A Class C
- IPC 1752A Class D

- Molex Product Compliance Declaration
- IEC-62474
- chemSHERPA (xml)

EU RoHS Certificate of Compliance

Part Details

General

Status	Active
Category	Passive Distribution Boxes
Series	120119
Description	MPIS Ultra-Lock (M12) Passive Junction Box, Top-Mount, 8 Ports / 4 Poles, PNP Sensor LED Indicators, 5.0m Length, Single IO Per Port
IP Rating	IP67
Product Name	Ultra-Lock (M12)
UPC	193264490707

Electrical

Current - Maximum per Contact	3.0A per port, 9.0A per module
Functional Wiring	PNP
Voltage - Maximum	10-30V DC
Wiring Configuration	Single I/O per Port

Physical

Bus I/O	Ultra-Lock (M12)
Cable Connector Orientation	Straight
Cable Length	5.0m
Home Run Cable Length	5.0m
Home Run Connector	N/A
Home Run Interface	Pigtail
Keyway	Single
LED Indicator	PNP Sensors
Material - Cable Jacket	TPU
Material - Housing	PBT
Material - Metal	Copper Alloy

Material - Plating Mating	Gold
Net Weight	565.000/g
Orientation	Top-Mount
Poles	4
Poles (wired)	4
Ports	8
Temperature Range - Operating	-25°C to +85°C
Wire/Cable Type	TPE

This document was generated on Mar 27, 2025