



**Part Number :** [1202510098](#)

**Product Description :** MPIS Ultra-Lock (M12) Passive Junction Box, Top-Mount, 8 Ports / 5 Poles, No LEDs, 1.0m Cable with Mini-Change (19-Pole) Home Run Connector, Dual IO Per Port

**Series Number :** 120119

**Status :** Active

**Product Category :** Passive Distribution Boxes

**Engineering Number :** BKB8120-FBW-01

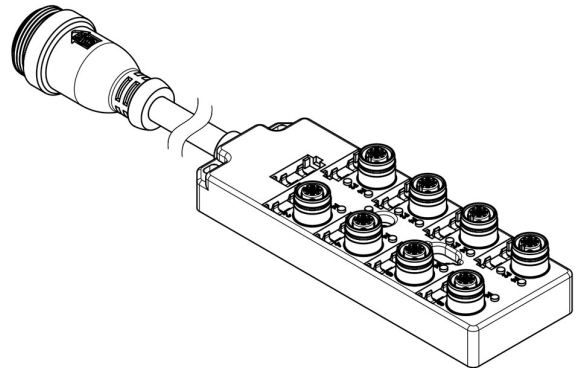

---

## Documents & Resources

### Drawings

[1202510098\\_sd.pdf](#)

---

## Product Environment Compliance

### Compliance

GADSL/IMDS	Not Relevant
China RoHS	Not Relevant
EU ELV	Not Reviewed per 2000/53/EC
Low-Halogen Status	Not Relevant
REACH SVHC	Contains Lead per D(2022)9120-DC (17 Jan 2023)
EU RoHS	Compliant with Exemption 6(c) per EU 2015/863

### Multiple Part Product Compliance Statements

- Eu RoHS
- REACH SVHC
- Low-Halogen

### Multiple Part Industry Compliance Documents

- IPC 1752A Class C
- IPC 1752A Class D
- Molex Product Compliance Declaration
- IEC-62474

## Part Details

### General

Status	Active
Category	Passive Distribution Boxes
Series	120119
Description	MPIS Ultra-Lock (M12) Passive Junction Box, Top-Mount, 8 Ports / 5 Poles, No LEDs, 1.0m Cable with Mini-Change (19-Pole) Home Run Connector, Dual IO Per Port
IP Rating	IP67
Product Name	Ultra-Lock (M12)
UPC	193264491025

### Electrical

Current - Maximum per Contact	3.0A per port, 9.0A per module
Functional Wiring	Parallel
Voltage - Maximum	10-30V DC
Wiring Configuration	Dual I/O per Port

### Physical

Bus I/O	Ultra-Lock (M12)
Cable Connector Orientation	Straight
Cable Length	1.0m
Home Run Cable Length	1.0m
Home Run Connector	Mini-Change - 19 pole
Home Run Interface	Cable - Side Entry
Keyway	Single
LED Indicator	None
Material - Cable Jacket	TPU
Material - Housing	PBT
Material - Metal	Brass
Material - Plating Mating	Gold

Net Weight	502.000/g
Orientation	Top-Mount
Poles	5
Poles (wired)	5
Ports	8
Temperature Range - Operating	-25°C to +85°C
Wire/Cable Type	TPE

---

This document was generated on Mar 27, 2025