



Part Number : [1204040052](#)

Product Description : Ultra-Lock 2.0 (M12) Receptacle, 8 Poles, Male (Straight) to Leads, A-Coded, Back Panel Mount, M16 Mounting Threads, 0.50m (1.64') Length

Series Number : 120404

Status : Active

Product Category : Circular Industrial Connectors

Engineering Number : YR8U46E02C500

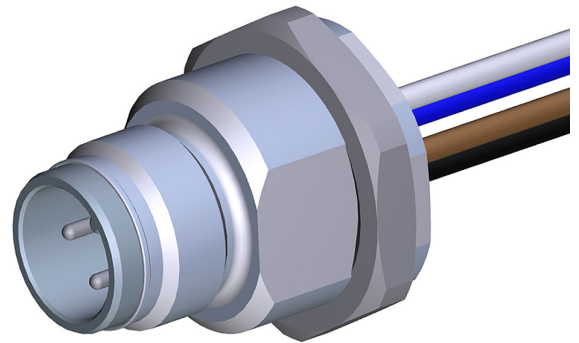

Documents & Resources

Drawings

[1204040052_sd.pdf](#)

Specifications

[1204000001-P10.pdf](#)

Product Environment Compliance

Compliance

GADSL/IMDS	Not Relevant
China RoHS	Not Relevant
EU ELV	Compliant with Exemption 3 per 2000/53/EC
Low-Halogen Status	Not Relevant
REACH SVHC	Contains Lead per D(2023)3788-DC (14 Jun 2023)
EU RoHS	Compliant with Exemption 6(c) per EU 2015/863

Multiple Part Product Compliance Statements

- Eu RoHS
- REACH SVHC
- Low-Halogen

Multiple Part Industry Compliance Documents

- IPC 1752A Class C

- IPC 1752A Class D
- Molex Product Compliance Declaration
- IEC-62474
- chemSHERPA (xml)

EU RoHS Certificate of Compliance

Part Details

General

Status	Active
Category	Circular Industrial Connectors
Series	120404
Description	Ultra-Lock 2.0 (M12) Receptacle, 8 Poles, Male (Straight) to Leads, A-Coded, Back Panel Mount, M16 Mounting Threads, 0.50m (1.64') Length
IP Rating	IP67, IP69K
Product Name	Ultra-Lock 2.0 (M12)
Type	Single Ended (pigtail)
UPC	195842411586

Agency

CSA	LR6837
-----	--------

Electrical

Current - Maximum per Contact	2.0A
Voltage - Maximum	30V

Physical

Coupling Type	External Thread Push to Lock
Gender	Male
Keyway	A-Coded
Length	0.50m
Material - Component	Nickel-plated Brass
Mounting Thread Size	M16
Net Weight	37.946/g
Orientation	Straight

Panel Mount	Back
Poles	8
Temperature Range - Operating	-40° to +90°C
Wire/Cable Type	Leads, UL 1569
Wire Size (AWG)	24

This document was generated on Mar 27, 2025