

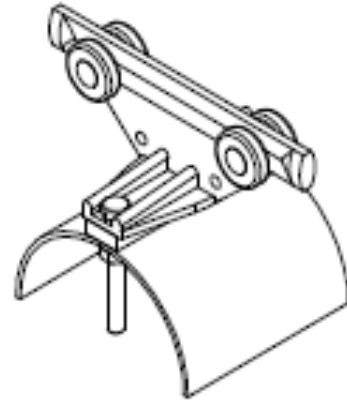

Part Number : 1301180020
Product Description : Box Track, Festoon Intermediate Car - 5410
Series Number : 130118
Status : Active
Product Category : Festoons
Engineering Number : 54101



Product Environment Compliance

Compliance

GADSL/IMDS	Not Relevant
China RoHS	Not Relevant
EU ELV	Not Relevant
Low-Halogen Status	Not Relevant
REACH SVHC	Not Reviewed per D(2024)7663-DC (21 Jan 2025)
EU RoHS	Not Relevant

Multiple Part Product Compliance Statements

- Eu RoHS
- REACH SVHC
- Low-Halogen

Multiple Part Industry Compliance Documents

- IPC 1752A Class C
- IPC 1752A Class D
- Molex Product Compliance Declaration
- IEC-62474
- chemSHERPA (xml)

EU RoHS Certificate of Compliance

Part Details

General

Status	Active
--------	--------

Category	Festoons
Series	130118
Description	Box Track, Festoon Intermediate Car - 5410
Component Type	Car - Intermediate
Product Name	Aero-Motive
Type	Box Track
UPC	78678863193

Physical

Cable Height - Maximum	19.05mm (.750")
Cable Width - Maximum	59.00mm (2.320")
Combined Cable Weight-Max./Car	24.95kg (55.0 lb)
Depth	89.92mm (3.540")
Duty	Standard - 25kg per Car
Height	144.78mm (5.700")
Length	144.78mm (5.700")
Material - Coating	Zinc
Material - Metal	Galvanized Steel
Material - Wheel	Steel - Sealed Ball Bearing
Net Weight	464.930/g
Number of Cars	1
Packaging Type	Individual Carton
Saddle Radius	71.88mm (2.830")
Thread Size	N/A
Wire/Cable Type	Flat