

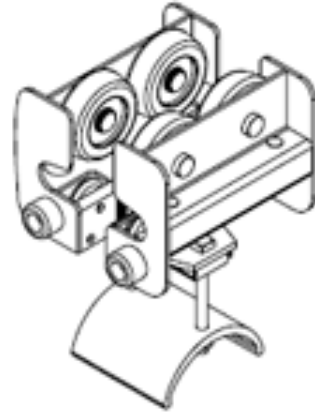

Part Number : 1301230053
Product Description : I-Beam Festoon
Intermediate Car 605 S5
Series Number : 130123
Status : Active
Product Category : Festoons
Engineering Number : 0605510



Product Environment Compliance

Compliance

China RoHS	Not Reviewed
EU ELV	Not Reviewed
Low-Halogen Status	Not Reviewed
REACH SVHC	Not Reviewed
EU RoHS	Not Reviewed

Multiple Part Product Compliance Statements

- Eu RoHS
- REACH SVHC
- Low-Halogen

Multiple Part Industry Compliance Documents

- IPC 1752A Class C
- IPC 1752A Class D
- Molex Product Compliance Declaration
- IEC-62474
- chemSHERPA (xml)

EU RoHS Certificate of Compliance

Part Details

General

Status	Active
Category	Festoons

Series	130123
Description	I-Beam Festoon Intermediate Car 605 S5
Component Type	Car - Intermediate
Product Name	Aero-Motive
Type	I-Beam
UPC	78678863067

Physical

Beam Size	S5 - 127.00mm
Cable Height - Maximum	19.05mm (.750")
Cable Width - Maximum	98.00mm (3.858")
Combined Cable Weight-Max./Car	79.38kg (175.0 lb)
Depth	137.92mm (5.430")
Duty	Heavy
Height	282.00 (11.100")
Length	254.00mm (10.000")
Material - Coating	Powder Coating
Material - Metal	Steel
Net Weight	936.710/g
Number of Cars	1
Packaging Type	Individual Carton
Saddle Radius	79.50mm (3.130")
Thread Size	N/A
Wire/Cable Type	Flat